

ELEVACION CIERRO CALLE MIRAFLORES
ESC. 1:100

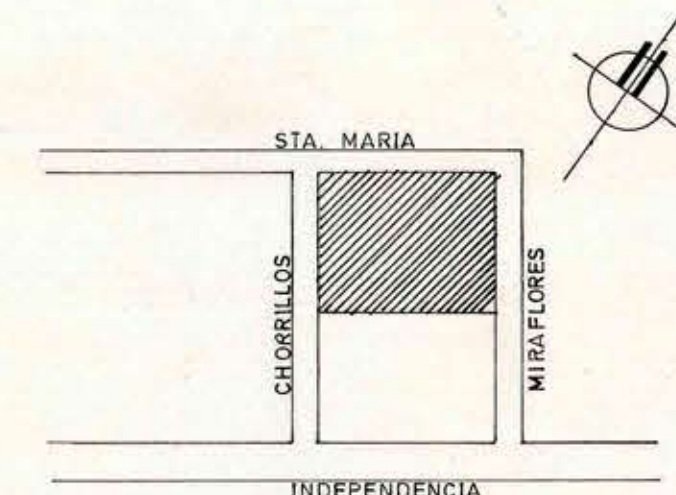

UBICACION
ESC. 1:5000

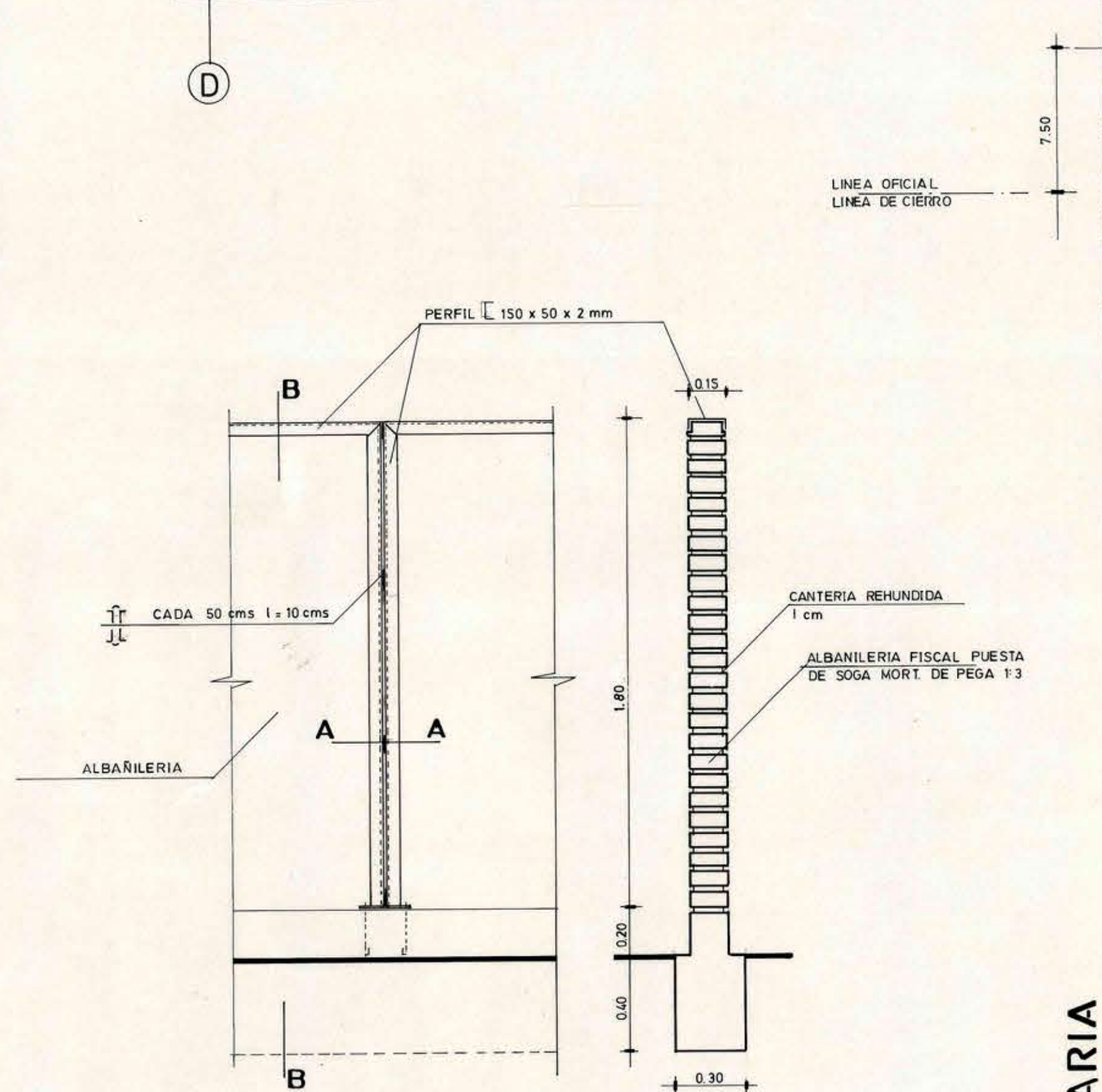

ELEVACION
ESC. 1:20

CORTE B-B

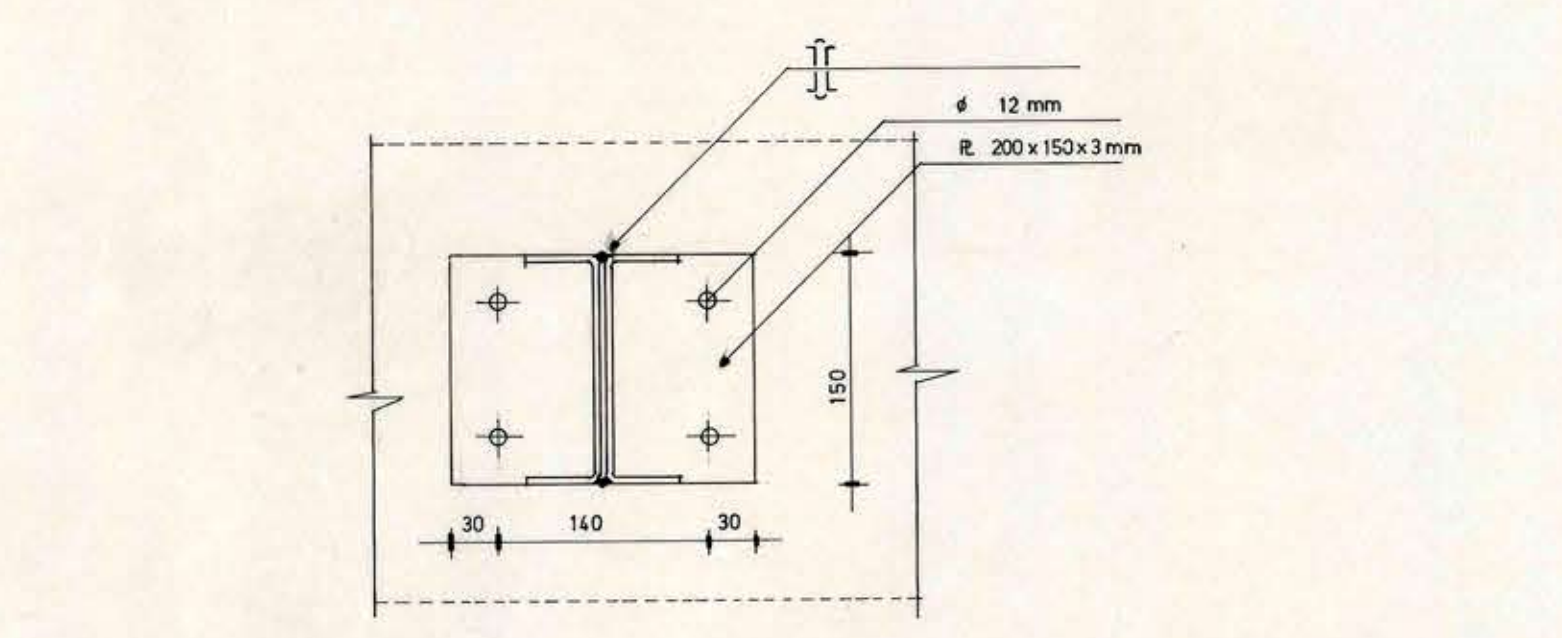

CORTE A-A
ESC. 1:5

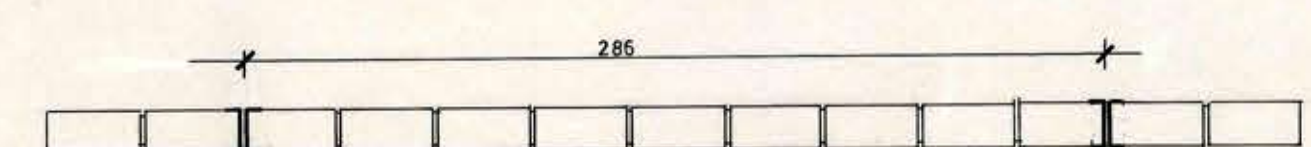

PLANTA CIERRO ALBAÑILERIA REF. ELEMENTOS METALICO CIERRO TIPO 1

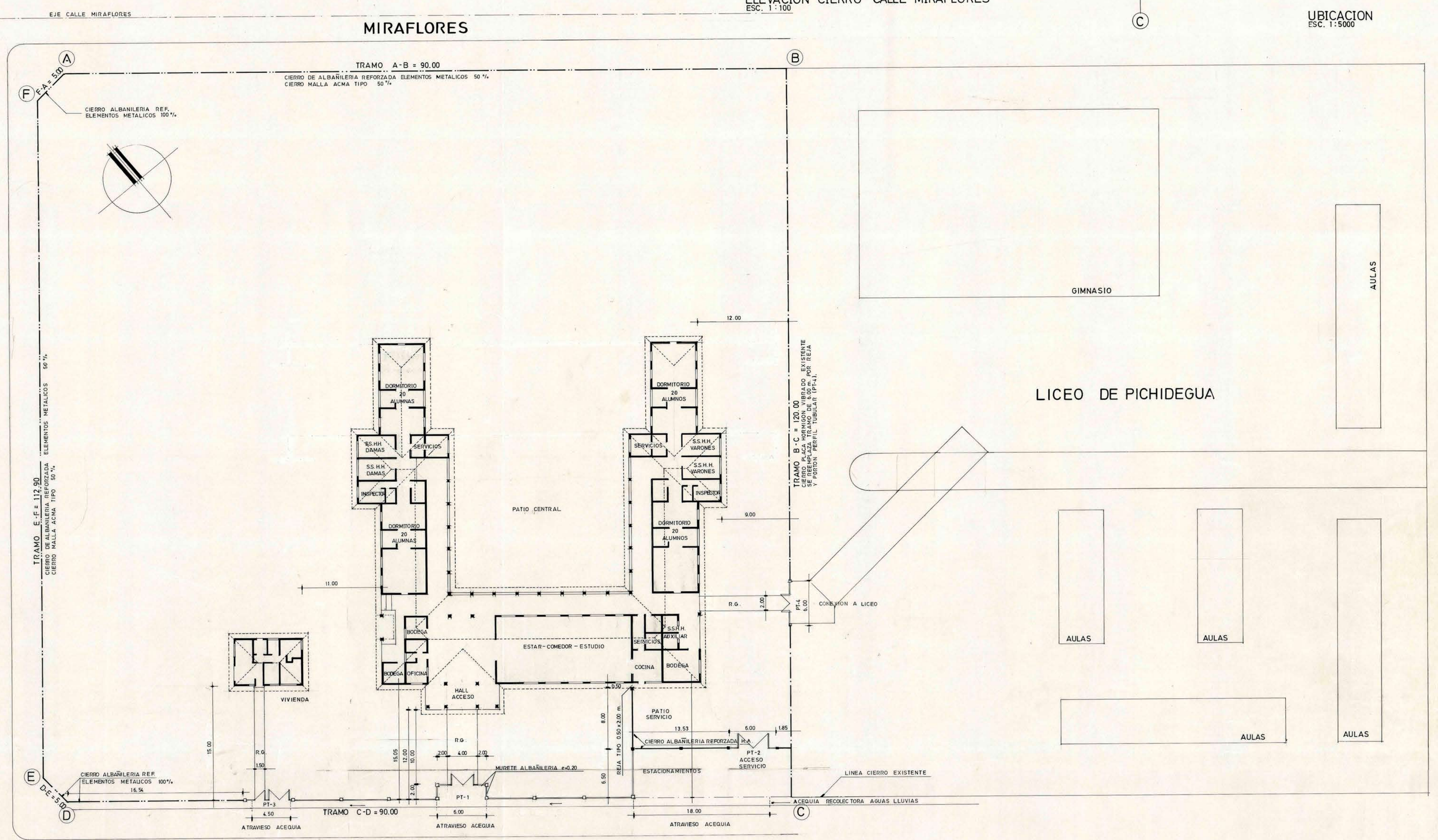

LICEO DE PICHIDEGUA

SANTA MARIA

INDEPENDENCIA

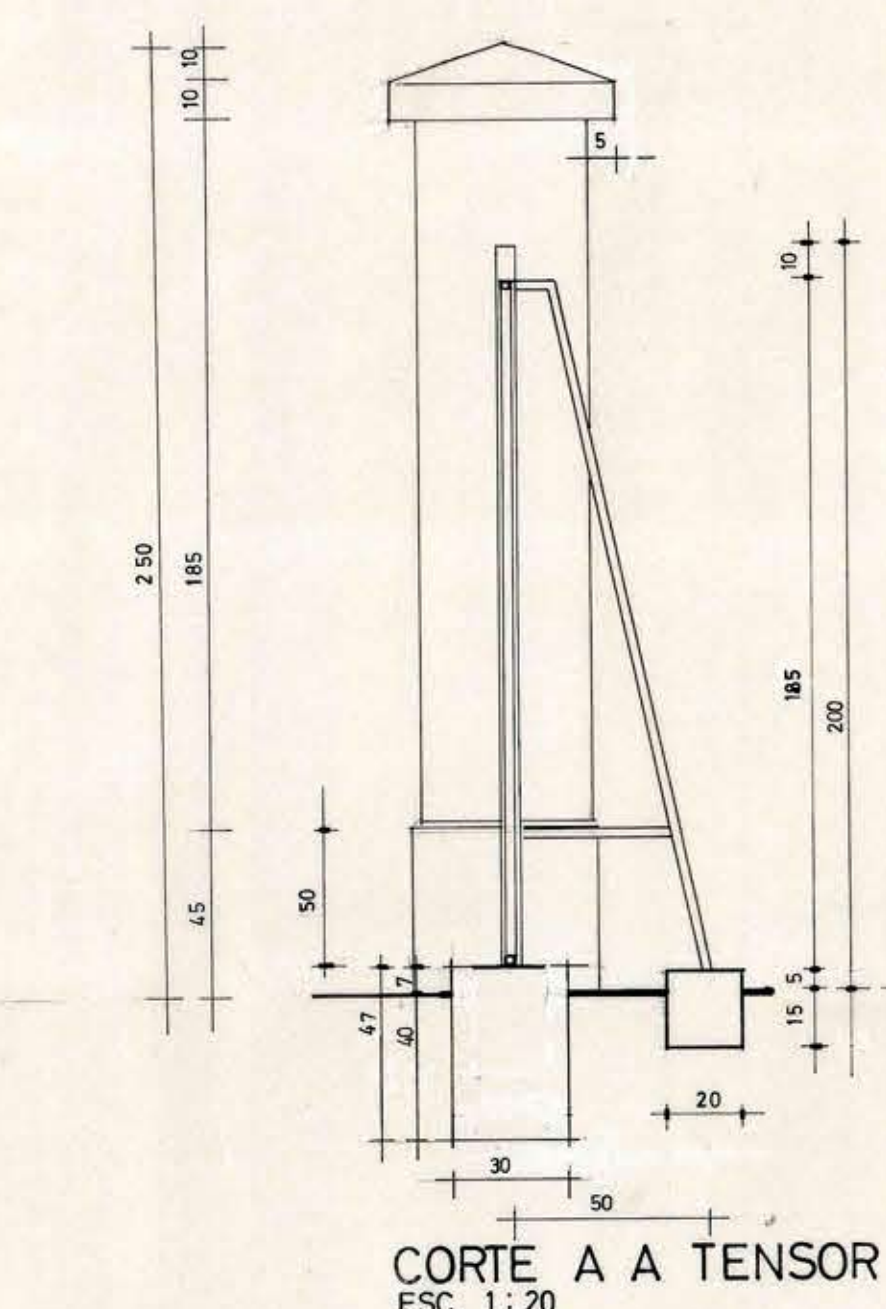

CORTE A A TENSOR
ESC. 1:20

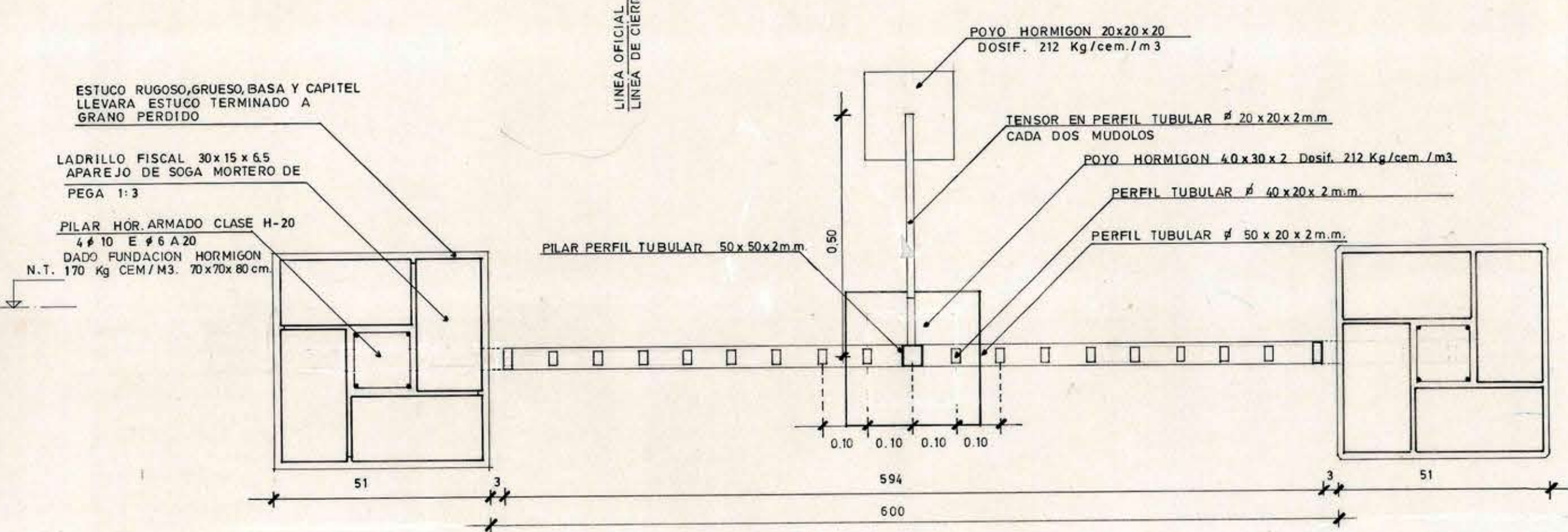

PLANTA MODULO REJA
ESC. 1:10

CHORRILLOS

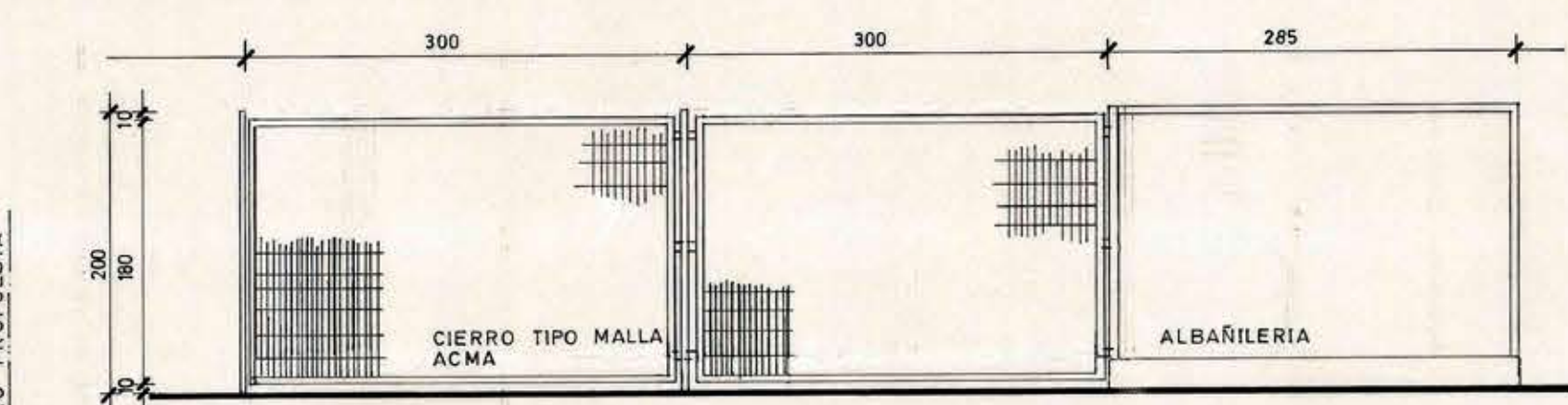

DETALLE TIPO CIERRO MALLA ACMA
ESC. 1:50

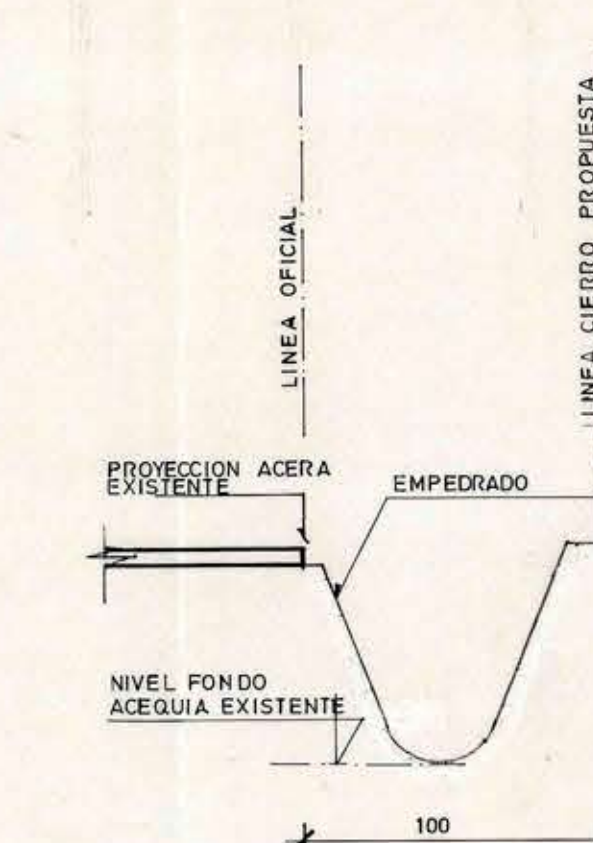

DETALLE CIERRO TIPO
ESC. 1:50

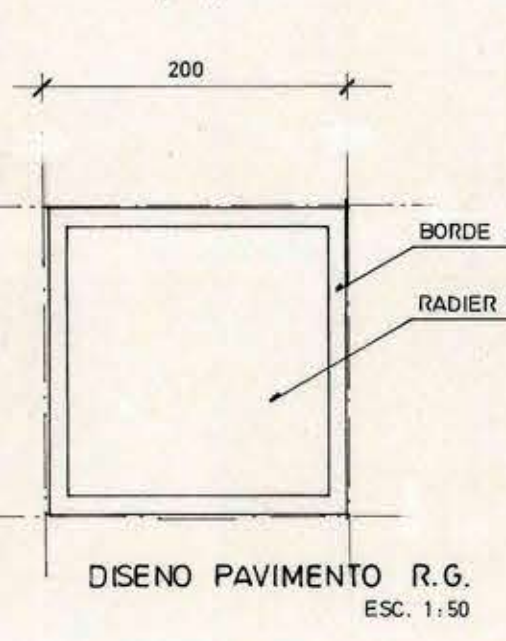
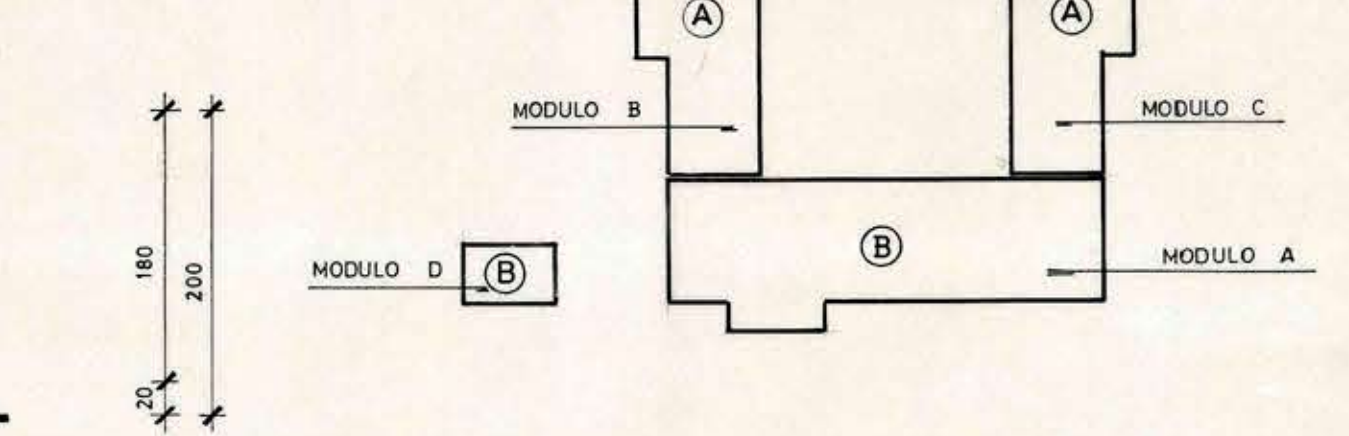

DISENO PAVIMENTO R.G.
ESC. 1:50

- (A) CONSTRUCCION INTERNADO DE PICHIDEGUA.
- (B) CONSTRUCCION VIVIENDA DIRECTOR Y SERVICIOS ANEXOS LICEO C-30 DE PICHIDEGUA

MOP REGION VI REGION PROVINCIA CACHAPOAL COMUNA PICHIDEGUA		DIRECCION DE ARQUITECTURA OFICINA REGIONAL VI REGION	
		OBRA: CONSTRUCCION INTERNADO DE PICHIDEGUA CONTENIDO: UBICACION EMPLAZAMIENTO DETALLE DE CIERROS	
ARQUITECTO: FRANCISCO HERNANDEZ D.	DIBUJO: F. HERNANDEZ D.	FECHA: OCTUBRE '92	CLAVE: A
SUPERFICIE: 990,22 M2	PLANO: 1 DE 12	ESCALA: LAS INDICADAS	